



USER GUIDE

T-REX-50KHP3G01

T-REX-40KHP3G01

T-REX-30KHP3G01

T-REX-29K9HP3G01

T-REX-25KHP3G01

Hybrid inverter

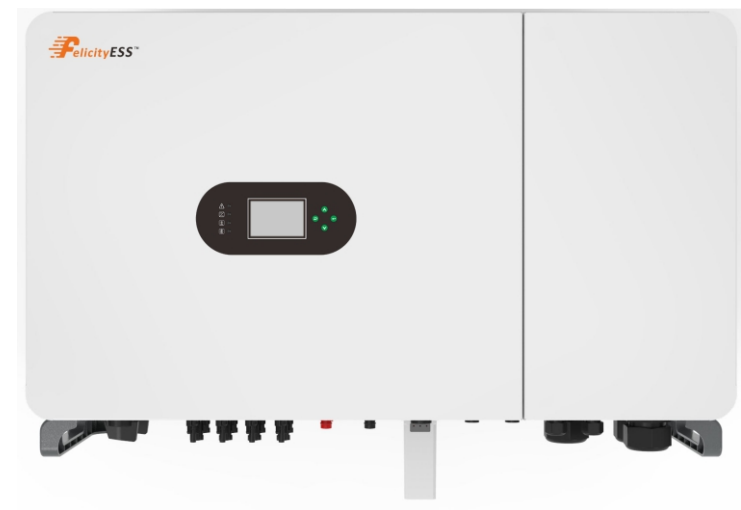

Contents

1. SAFETY & WARNING	2
2 Product Introduction	2
2.1 Products overview	4
3 INSTALLATION	5
3.1 Packing List.....	5
3.2 Installation tools	6
3.3 Installation Environment	6
3.4 Mounting	8
4. ELECTRICAL CONNECTION	9
4.1 PV Connection	9
4.2 Battery Connection.....	11
4.3 Grid, Load and Gen port connection	12
4.4 Smart Meter & CT Connection	14
4.5 DRMS Connection	16
4.6 Lithium Battery Communication	18
4.7 Installation of WIFI module	19
4.8 Function Port Definition	19
4.9 Typical application diagram of grid power	21
4.10 Typical application diagram of diesel generator	24
5. Display and operation	25
5.1 Operation and Display Panel.....	25
5.2 LCD Display Icons.....	25
5.3 Solar Power Curve.....	26
5.4 Battery Setting.....	27
5.5 System Work Mode	29
5.6 Grid Setting	32
5.7 Generator Setting	36
6. Work Mode	38
7. APP Download the app	44
8. Warning Code	44
9. Fault Code	45
10. Appendix	49

About This Manual

The manual mainly describes the product information, guidelines for installation, operation and maintenance. The manual cannot include complete information about the photovoltaic (PV) system.

How to Use This Manual

Read the manual and other related documents before performing any operation on the inverter. Documents must be stored carefully and be available at all times. Contents may be periodically updated or revised due to product development. The information in this manual is subject to change without notice. The latest manual can be acquired via our website at <https://www.felicityess.com> for latest version.









Safety Introductions

This chapter contains important safety and operating instructions. Read and keep this manual for future reference.

- Before using the inverter, please read the instructions and warning signs of the battery and corresponding sections in the instruction manual.
- Do not disassemble the inverter. If you need maintenance or repair, take it to a professional service center.
- Improper reassembly may result in electric shock or fire.
- To reduce risk of electric shock, disconnect all wires before attempting any maintenance or cleaning. Turning off the unit will not reduce this risk.
- Caution: Only qualified personnel can install this device with battery.
- Never charge a frozen battery.
- For optimum operation of this inverter, please follow required specification to select appropriate cable size. It is very important to correctly operate this inverter.
- Be very cautious when working with metal tools on or around batteries. Dropping a tool may cause a spark or short circuit in batteries or other electrical parts, even cause an explosion.
- Please strictly follow installation procedure when you want to disconnect AC or DC terminals. Please refer to "Installation" section of this manual for the details.
- Grounding instructions - this inverter should be connected to a permanent grounded wiring system. Be sure to comply with local requirements and regulation to install this inverter.
- Never cause AC output and DC input short circuited. Do not connect to the mains when DC input short circuits.

1. SAFETY & WARNING

This manual provides relevant information with icons to highlight the physical and property safety of the user to avoid device damage and physical injury. The Symbols used in this manual are listed as below:

Symbols	Name	Instruction
	Danger	Serious physical injury or even death may occur if not follow the relative requirements
	Warning	Physical injury or damage to the devices may occur if not follow the relative requirements
	Electrostatic sensitive	Damage may occur if not follow the relative requirements
	Hot surface	Sides of the device may become hot. Do not touch.
	Earth terminal	The inverter must be reliably grounded.
	Caution	Ensure that DC and AC side circuit breakers have been disconnected and wait at least 5 minutes before wiring and checking.
NOTE	Note	The procedures taken for ensuring proper operation.
	CE mark	The inverter complies with the CE directive.
	EU WEEE mark	Product should not be disposed as household waste.

2. Product Introduction

FelicityESS T-REX-50KHP3G01 is a multifunctional inverter, combining functions of inverter, solar charger and battery charger to offer uninterruptible power support with portable size. Its comprehensive LCD display offers user configurable and easy accessible button operation such as battery charging, AC/solar charging, and acceptable input voltage based on different applications.

Product Features

- 3.5-inch LCD touch screen.
- configurable parameters and working mode by LCD.
- Supporting WIFI monitoring and F solar Smart Cloud Monitoring System.
- 8-channel PV, 4-channel MPPT, 1.3 times overconfiguration capacity.
- 2 independent battery inputs, effectively reducing inter-cluster circulation.
- Wide battery voltage input, each battery charge and discharge current up to 50A.
- Programmable generator port, support smart load and microinverter access.
- The off-grid switching time is less than 10ms to prevent important loads from losing power.
- The maximum support is 12 parallel machines.
- Support multi Working mode, Time of use, Selling first, Zero export to load, zero export to CT, Dispatch mode.
- IP65 protection level.

Basic System Architecture

The following illustration shows basic application of this inverter.

It also includes following devices to have a complete running system.

- Generator or Utility
- PV modules

Consult with your system integrator for other possible system architectures depending on your requirements.

This inverter can power all kinds of appliances in home or office environment, including motor type appliances such as refrigerator and air conditioner.

Please refer to the Figure2.1-1 for details.

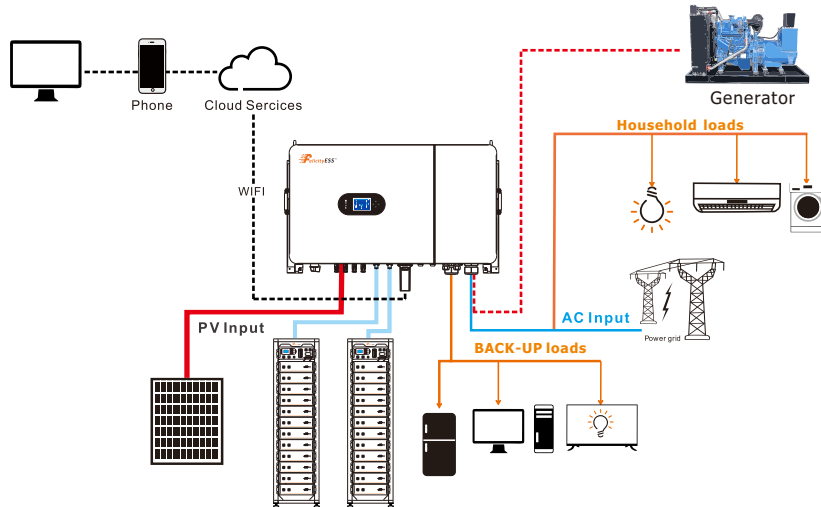

Figure 2.1-1 Block diagram of hybrid solar inverter system

2.1 Products overview

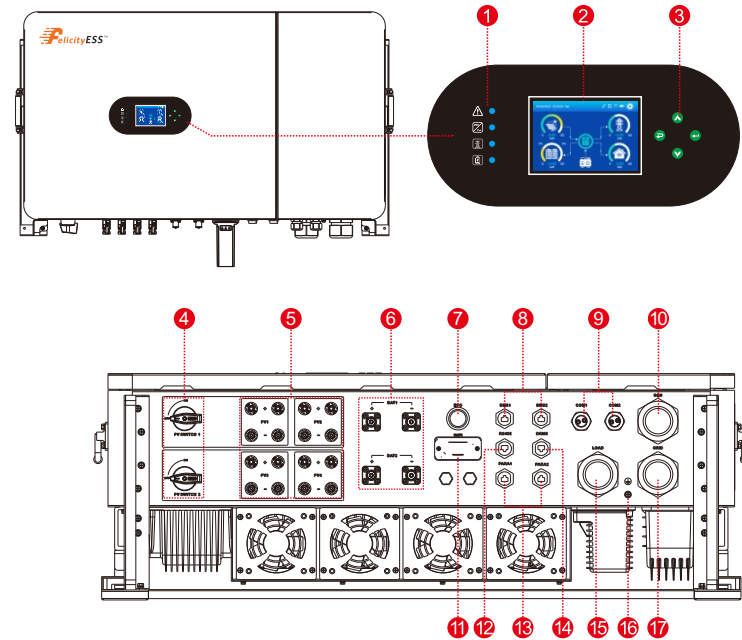

Figure 2.2-1 Products overview

- | | | |
|-----------------------------|-----------------------------|---------------|
| 1. Inverter Indicators | 7. EPO | 13. PARA port |
| 2. LCD display | 8. BMS port | 14. DRMs port |
| 3. Button | 9. COM port | 15. LOAD |
| 4. PV switch | 10. Generator | 16. PE |
| 5. PV input connection port | 11. WIFI Communication port | 17. GRID |
| 6. Battery connection port | 12. RS485 port | |

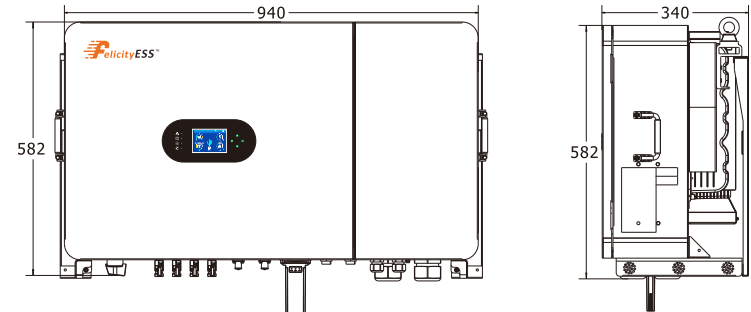

Figure 2.2-2 Inverter dimensions

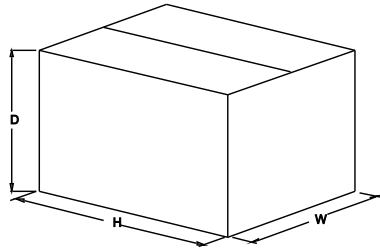

Figure 2.2-3 Paper packages dimension

Table 2-4 Packages dimension and gross weight

Model	H (mm)	W (mm)	D (mm)	Net Weight (KG)	Gross Weight (KG)
T-REX-50KHP3G01	463	770	1110	85.6	98.4

3 Installation

3.1 Packing List

The inverter 100% strictly inspected before package and delivery. Please check the product package and fittings carefully before installation.

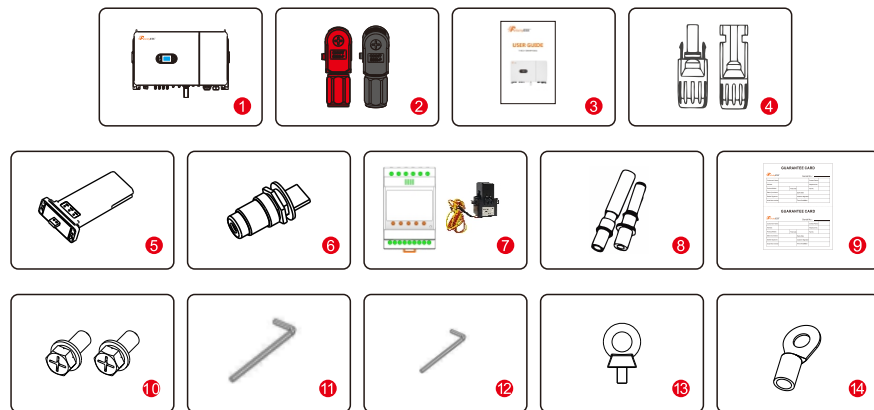

Figure 3.1-1 Packing List

Table 3.1-1 Detailed delivery list

No.	Name	Quantity
1	Inverter	1
2	Battery connector	2 pair
3	Operation manual	1
4	DC connector	8 pairs
5	WiFi module	1
6	COM connector	6
7	Meter or CT(optional)	3
8	Expansion Bolts	4
9	Guarantee card	1
10	M5 combination screw	2
11	M10 Allen wrench	1
12	M5 Allen wrench	1
13	Ring	2
14	OT terminals	1

3.2 Installation tools



Figure 3.2-1 Installation tools

3.3 Installation Environment

- ◇ Choose a dry, clean, and tidy place, convenient for installation
- ◇ Ambient temperature range: -25°C ~ 60°C
- ◇ Relative humidity: 0 ~ 100% (non-condensed)
- ◇ Install in a well-ventilated place
- ◇ No flammable or explosive materials close to inverter
- ◇ The AC overvoltage category of inverter is category III
- ◇ Maximum altitude: 2000m



• Inverter cannot be installed near flammable, explosive or strong electromagnetic equipment.

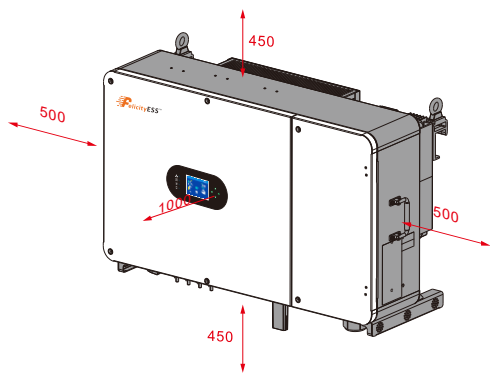

Figure 3.3-1 Installation space of one inverter

Considering the following points before selecting where to install:

- Please select a vertical wall with load-bearing capacity for installation, suitable for installation on concrete or other non-flammable surfaces, installation is shown below.
- Install this inverter at eye level in order to allow the LCD display to be read at all times.
- The ambient temperature should be between -25~60°C to ensure optimal operation.
- Be sure to keep other objects and surfaces as shown in the diagram to guarantee sufficient heat dissipation and have enough space for removing wires.

Table 3-3-1 Detailed installation space

	Minimum clearance
Lateral	500mm
Top	450mm
Bottom	450mm

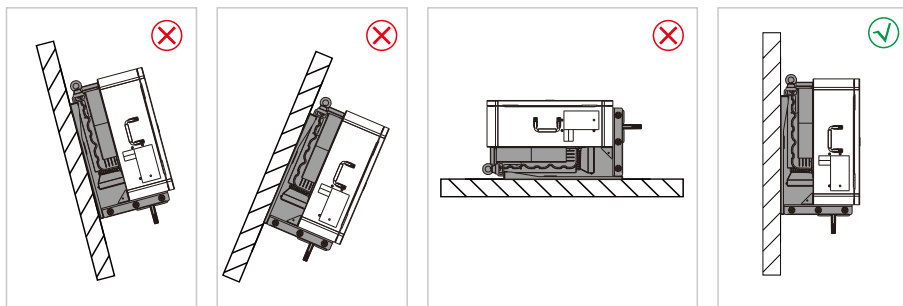

Figure 3.3-2 Installation position



• Do not open the cover of the inverter or replace any part as incomplete inverter may cause electric shock and damage the device during operation.

The installation of inverter should be protected under shelter from direct sunlight or badweather like snow,rain, lightning etc.

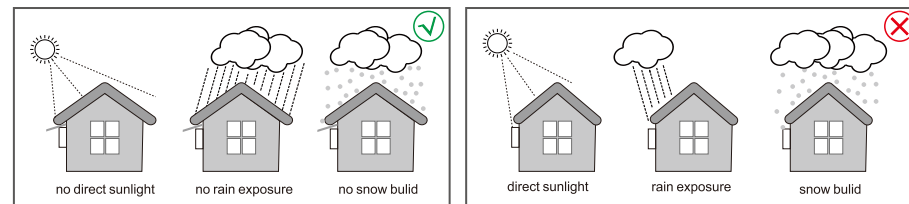

Figure 3.3-3 Installation position

3.4 Mounting



• The inverter is heavy, please be careful when removing it from the package.

The inverter is suitable for mounting on concrete or other non-combustible surface only.

Step 1. Please use the mounting bracket as a template to drill 5 holes in the right positions (10mm in diameter, and 80mm in depth). Use M8 expansion bolts in accessory box and fix the mounting With a 12mm drill bracket onto the wall tightly. The installation of inverter support is shown in Figure 3.4-1.

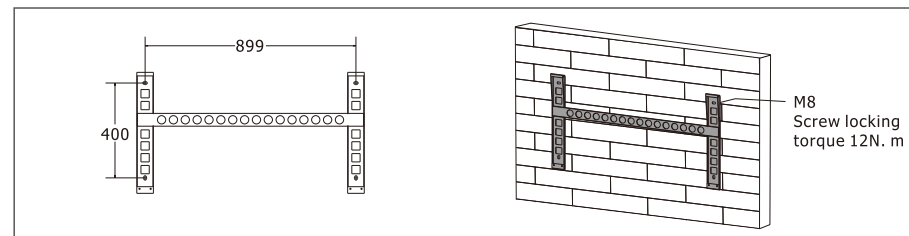

Figure 3.4-1 Install Inverter hanging plate

Step 2. Lift the inverter to suspend it on the installation bracket, We can prevent theft by locking. See Figure 3.4-2.

NOTE

• Be careful when mounting because the inverter is very heavy.

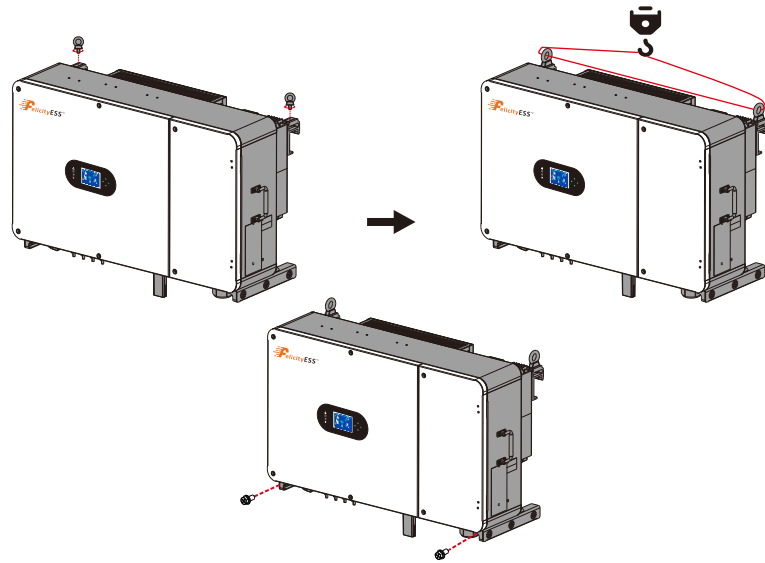
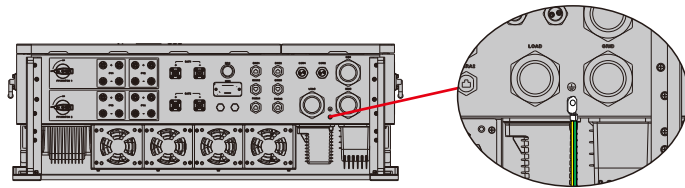

Figure 3.4-2 Installing an Inverter



Screw locking torque 2N. m

Figure 3.4-3 Rack earth (Ground wire locked by M5)

4 Electrical Connection

- ◇ High voltages in power conversion circuits. Lethal hazard of electric shock or serious burns.
- ◇ All work on the PV modules, inverters, and battery systems must be carried out by qualified personnel only.
- ◇ Wear rubber gloves and protective clothing (protective glasses and boots) when working on high voltage/high current systems such as INVERTER and battery systems.

4.1 PV Connection

Before connecting PV panels/strings, please make sure requirements are followed as below:

- (1) The total short-circuit current of PV string must not exceed inverter's max DC current.
- (2) The minimum isolation resistance to ground of the PV string must exceed 33.33kΩ in case of any shock hazard.
- (3) PV string could not connect to earth/grounding conductor.
- (4) Use the right PV plugs in the accessory box.

Wire Size	Cable(mm)
10~12AWG	7

Step 1. Prepare PV positive and negative power cables

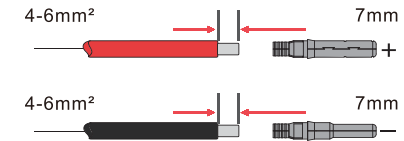

Figure 4.1-1 pv cables and pv plugs

Step 2. Connect PV cables to PV connectors. See Figure 4.1-2.

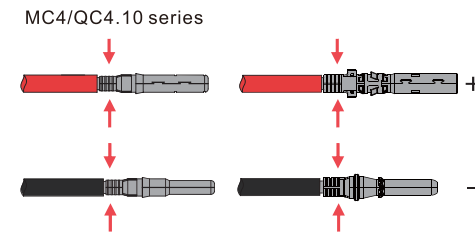

Figure 4.1-2 PV cables to PV connectors

NOTE

- PV cables must be tightly crimped into the connectors.
- For Amphenol connector, the limit buckle cannot be pressed.
- There will be a "click" sound if connectors are inserted correctly into PV plugs.

Step 3. Screw the cap on and plug it onto inverter side. There will be a click sound if connectors are inserted correctly into PV plugs. See Figure 4.1-3.

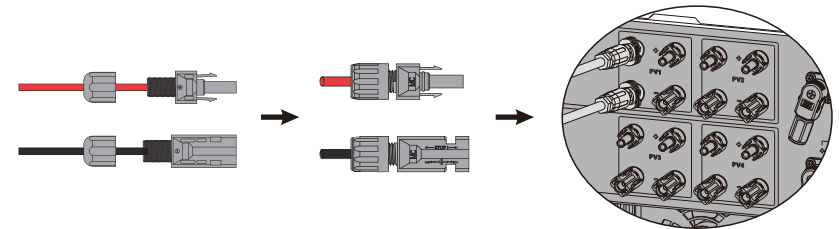

Figure 4.1-3 The PV plug is connected to the inverter



•The polarity of PV strings cannot be connected reversely, otherwise the inverter could be damaged.

4.2 Battery Connection

Please be careful about any electric shock or chemical hazard. Make sure there is an external DC breaker (25A) connected to the battery without build-in DC breaker.



•The polarity of battery cannot be connected reversely, otherwise the inverter could be damaged.

Wire Size	Cable(mm)
4AWG	16

Step 1. Prepare battery cables and accessories, and route the battery power cable through the battery cover. Use accessories box accessories, battery power cable 25mm².

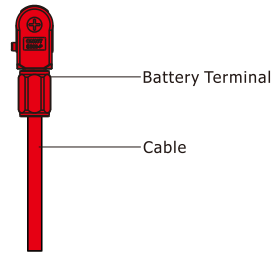

Figure 4.2-1 Battery cable and battery case

Step 2. Make battery terminals. Strip cable coat, revealing 10mm length of metal core. Use special crimper to compress battery terminal tightly.

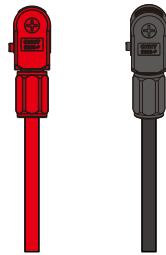

Figure 4.2-2 The battery terminal

Step 3. Connect the battery terminal to the inverter. Ensure that the battery polarity is connected correctly.

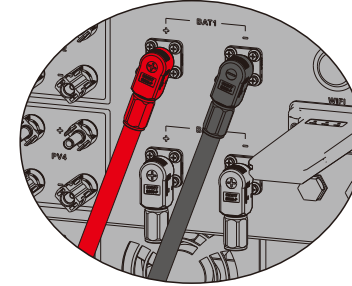

Figure 4.2-3 The battery terminal is connected to the inverter

4.3 Grid, Load and Gen port connection

An external AC breaker is needed for on-grid connection to isolate from grid when necessary. The requirements of on-grid AC breaker are shown as below.

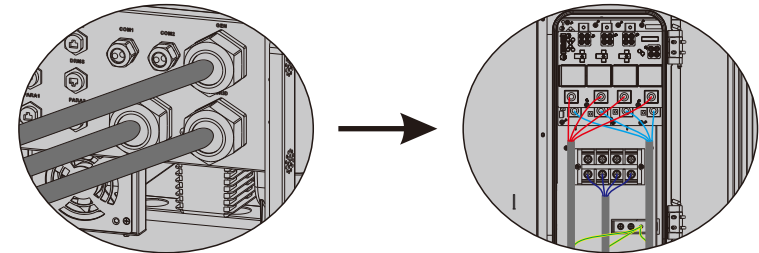

Figure 4.3-1 Install AC cables for the inverter



•Don't connect the PE wire wrong.

Table 4.3-1 : Recommended table of AC circuit breakers

INVERTER MODEL	AC BREAKER SPECIFICATION
T-REX-50KHP3G01	72A/400V,4P

NOTE

• The absence of AC breaker on back-up side will lead to inverter damage if an electrical short circuit happens on back-up side.

1. On the AC side, the individual breaker should be connected between inverter and Grid but before loads. See Figure 4.3-2.

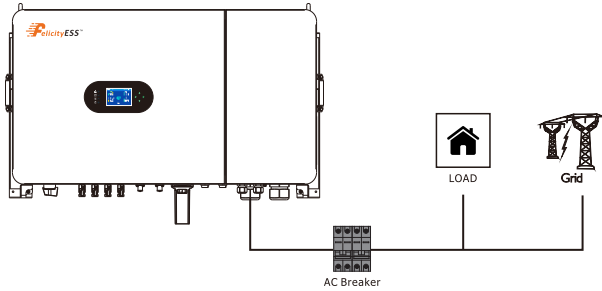

Figure 4.3-2 Ac breaker connection



• Make sure the inverter is totally isolated from any DC or AC power before connecting AC cable.

Step 1. Prepare the terminals and AC cables according to the right table. See Figure 4.3-3.

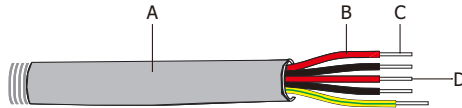

Figure 4.3-3 Ac connection line

Table 4.3-2 : Ac cable specifications

Grade	Description	Value
A	Outside diameter	30-40mm
B	Separated wire length	200-250mm
C	Conductor wire length	20-25mm
D	Conductor core section	15-20mm

Step 2. Peel off the skin of the AC cable and thread the AC cable through the Screw Cap. See Figure 4.3-4.

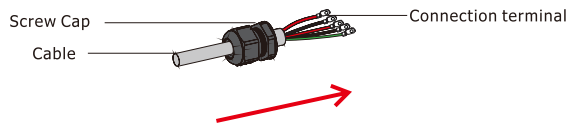

Figure 4.3-4 The AC cable passes through the terminal cover

Step 3. Install the AC connection terminal on the cable. See Figure 4.3-5.

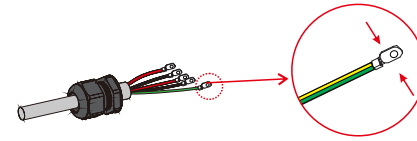

Figure 4.3-5 Install ac connection terminals

NOTE

• The absence of AC breaker on back-up side will lead to inverter damage if an electrical short circuit happens on back-up side.

Step 4. Thread the AC cable through the Screw Cap and connect to the inside of the inverter. Then tighten the Screw Cap. See Figure 4.3-6.

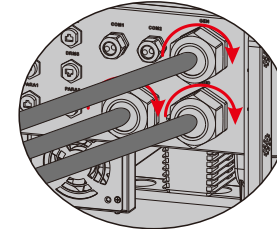

Figure 4.3-6 Install ac connection terminals

4.4 Smart Meter & CT Connection



Figure 4.4-1 Smart Meter

Signal terminal: "5, 6, 7, 8, 9, 10" is the terminal number of the input current signal; "1, 2, 3, 4" is the terminal number of the input voltage signal;

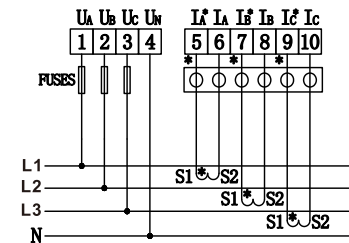

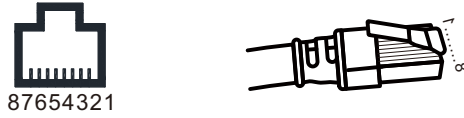
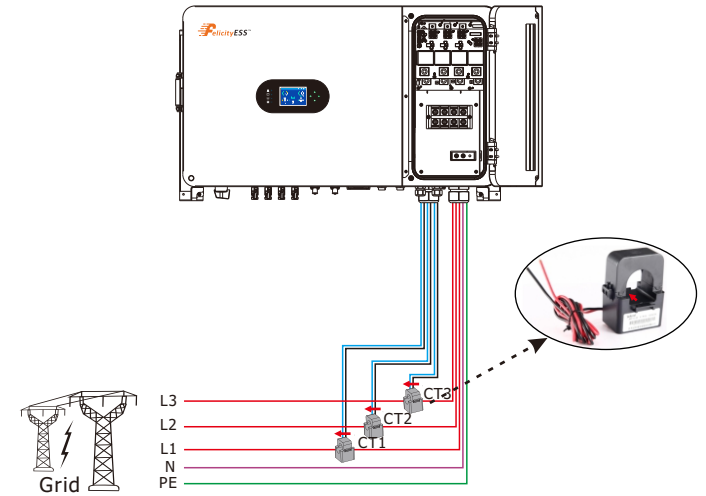
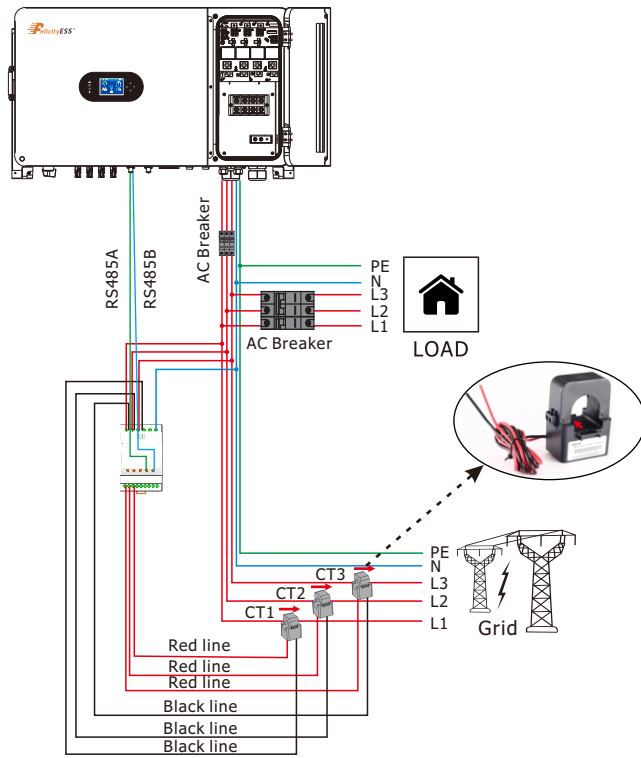

Figure 4.4-2 RS485 interface

Table:4.4-1:RS485 interface

NO.	1	2	3	4	5	6	7	8
Function	CANB_L	CANB_H	PC_485_B	PC_485_A	Meter/485B	Meter/485A	Scope/485B	Scope/485A

The Smart Meter with CT in product box is compulsory for T-REX system installation, used to detect grid voltage and current direction and magnitude, further to instruct the operation condition of T-REX inverter via RS485 communication. See Table 4.4-2.



4.5 DRMS Connection

DRMS(Demand response enabling device) is used for Australia and New Zealand installation (also used as remote shutdown function in European countries), in compliance with Australia and New Zealand safety requirements(or European countries). Inverter integrates control logic and provides an interface for DRMS. The DRMS is not provided by inverter manufacturer. Detailed connection of DRMS & Remote Shutdown are shown below:

Step 1. Screw this plate off from the inverter. See Figure 4.5-1.

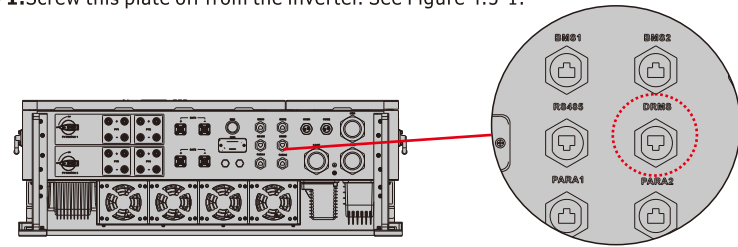

Figure 4.5-1 DRMS interface

Step 2. Plug out the RJ45 terminal and dismantle the resistor on it. Plug the resistor out, leave the RJ45 terminal for next step.

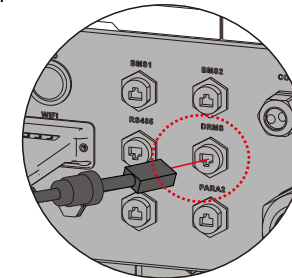

Figure 4.5-2 operating steps

NOTE

•The RJ45 terminal in the inverter has the same function as DRED.
Please leave it in the inverter if no external device is connected.

Step 3-1 Pass the RJ45 cable through the steel plate and connect the DRED cable to the RJ45 terminal. As shown in Figure 4.5-3, Table 4-9 describes the 6-pin port definition.

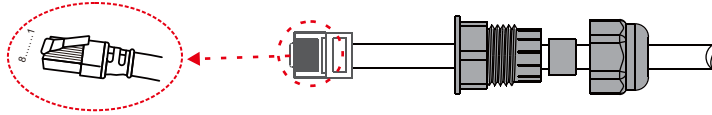

Figure 4.5-3 operating steps

Table 4.5-1 :Port pin allocation table

NO.	1	2	3	4	5	6	7	8
Function	DRM1/5	DRM2/6	DRM3/7	DRM4/8	REF	COM	/	/

Step 3-2 For Remote Shutdown. Run the cable through the steel plate , Then wire from pins 5 and 6. Table 4.5-1 describes the 6-pin port definition,Wiring is shown in Figure 4.5-4.

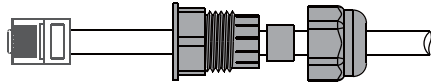

Figure 4.5-4 Remotely close the cable connection

Step 4. Connect RJ45 terminal to the right position onto the inverter.See Figure 4.5-5.

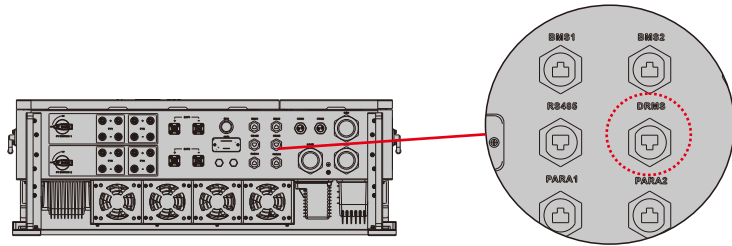

Figure 4.5-5 RJ45 interface

4.6 Lithium Battery Communication

It's allowed to connect lithium battery and build communication only which it has been configured. Please follow bellow steps to configure communication between lithium battery and inverter.

1. Connect power cables between lithium battery and inverter. Please pay attention to the terminals of positive and negative. Make sure the positive terminal of battery is connected to the positive terminal of inverter, and the negative terminal of battery is connected to the negative terminal of inverter.
2. The communication cable is bundled with lithium battery. Both sides are RJ45 port. One port is connected to the BMS port of inverter and another one is connected to the PCS port of lithium battery.

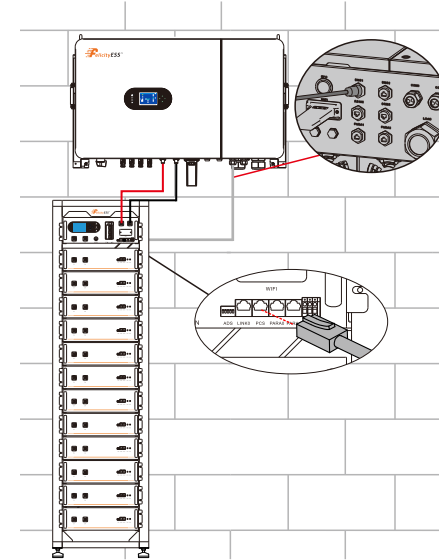

Table 4.6-1 :Detailed Pin Function Of BMS Port On T-REX

Position	Function	
1	/	
2	/	
3	/	
4	BMS/CANH	
5	BMS/CANL	
6	GND	
7	BMS/485B	
8	BMS/485A	

4.7 Installation of WIFI module

The WiFi communication function applies only to the WiFi module. For details, see Figure 4.8-1 installing a WiFi module.

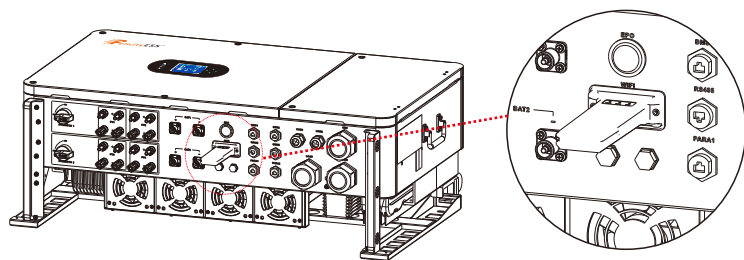
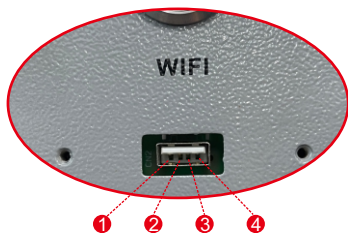

Figure 4.7-1 WiFi Module installation

Table 4.7-2 : WiFi Module installation Table

NO.	1	2	3	4
Function	VCC	GND	WIFI/232RX	WIFI/232TX



4.8 Function Port Definition

Table 4.8-1 :Detailed Pin Function Of SW1 Port On T-REX

No.	Position	Function
1	DIP1	PARA/CAN ON: 120 Ω matching resistor input OFF: 120 Ω matching resistor cut out
2	DIP2	BMS2/485 ON: 120 Ω matching resistor input OFF: 120 Ω matching resistor cut out
3	DIP3	BMS1/485 ON: 120 Ω matching resistor input OFF: 120 Ω matching resistor cut out
4	DIP4	BMS2/CAN ON: 120 Ω matching resistor input OFF: 120 Ω matching resistor cut out
5	DIP5	BMS1/CAN ON: 120 Ω matching resistor input OFF: 120 Ω matching resistor cut out

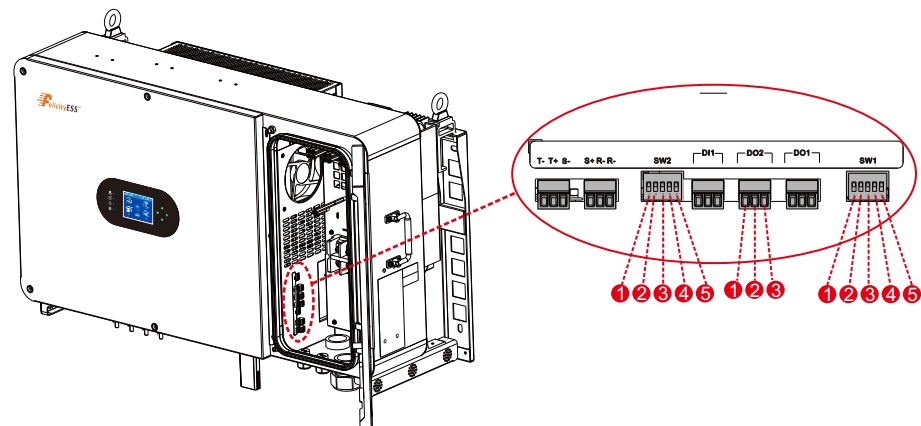

Figure 4.8-1 Function Port Definition

Table 4.8-2 :Detailed Pin Function Of SW2 Port On T-REX

No.	Position	Function
1	DIP1	ON: R-phase CT transformation ratio 1500:1 OFF: R-phase CT ratio 3000:1
2	DIP2	ON: S-phase CT transformation ratio 1500:1 OFF: S-phase CT ratio 3000:1
3	DIP3	ON: T-phase CT transformation ratio 1500:1 OFF: T-phase CT ratio 3000:1
4	DIP4	/
5	DIP5	/

Table 4.8-3 :Detailed Port Function Of DI1, DO1, DO2 Port On T-REX

No.	Position	Function
1	DI1	Dry contact input,reserved.
2	DO1	Dry contact output,reserved.
3	DO2	Dry contact output signal for startup the diesel generator. (PIN1/2,normal close. PIN2/3,normal open)

4.9 Typical application diagram of grid power

Scenario 1: If there are two high-voltage battery clusters (BAT1 and BAT2), battery cluster 1 is connected to the BAT1 port of the inverter, and the CAN communication line is connected to the BMS1 port of the inverter; Battery cluster 2 is connected to the BAT2 port of the inverter, and the CAN communication line is connected to the BMS2 port of the inverter.

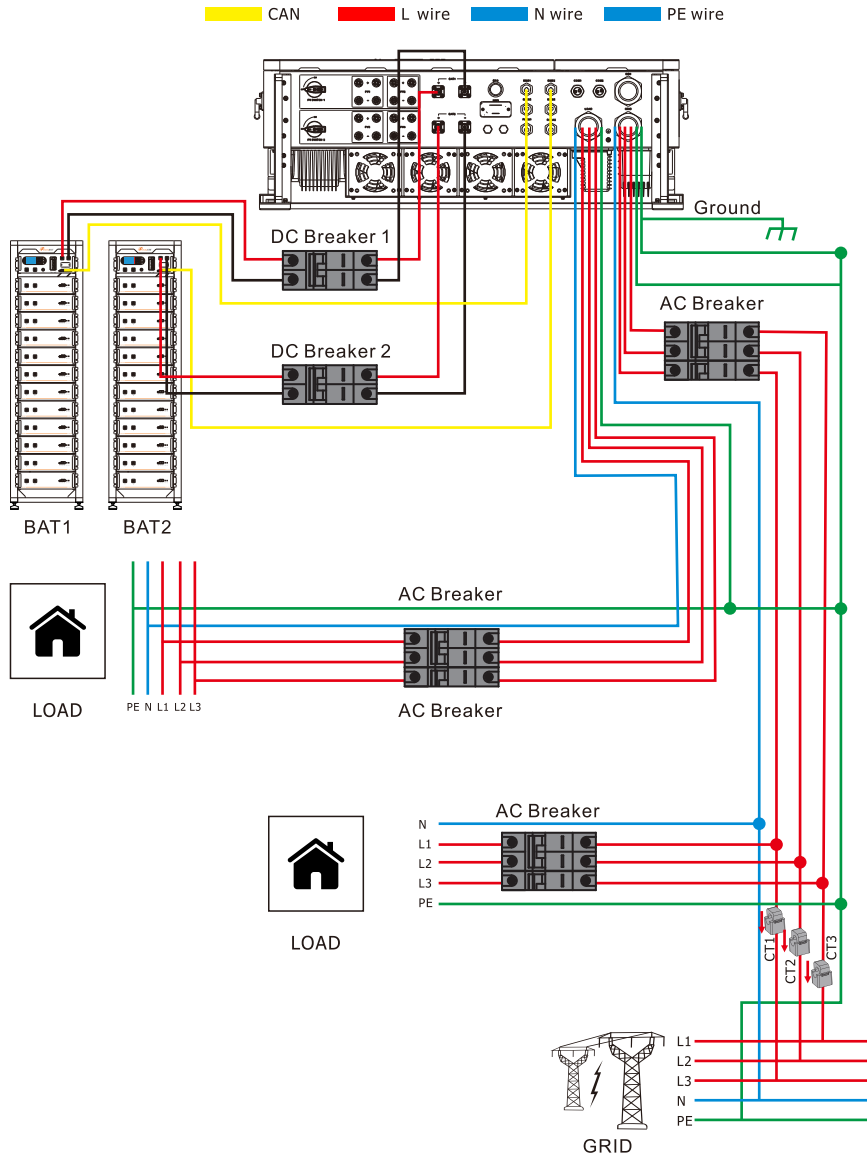

Scenario 2: If there is only one high-voltage battery cluster (BAT), the battery cluster is connected to the BAT1 port of the inverter, and the CAN communication line is connected to the BMS1 port of the inverter; Alternatively, the battery cluster can be connected to the BAT2 port of the inverter, while the CAN communication line can be connected to the BMS2 port of the inverter.

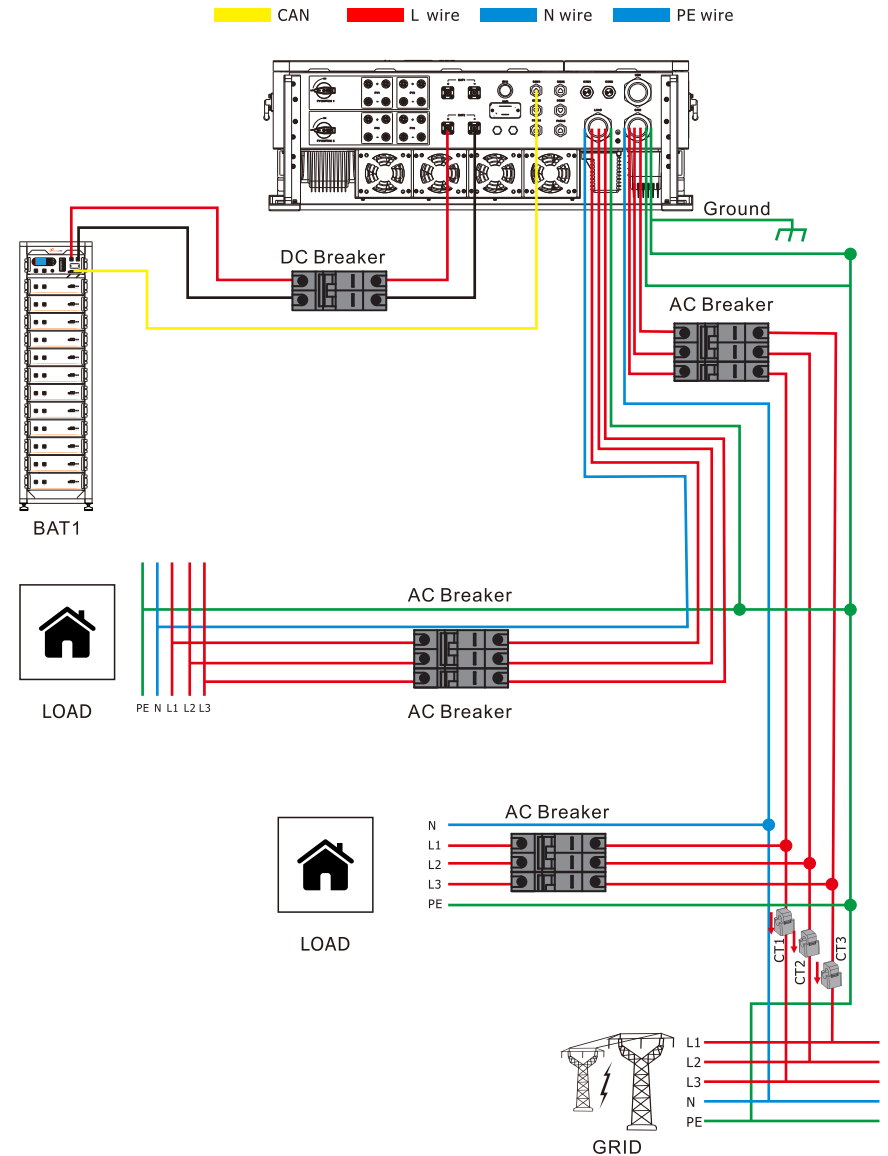

Scenario 3: If there is only one high-voltage battery cluster (BAT), the battery output can be connected to both BAT1 and BAT2 interfaces, and the CAN communication line must be connected to the BMS1 port of the inverter. Additionally, it is necessary to set "Parallel bat1 & bat2" in on the screen.

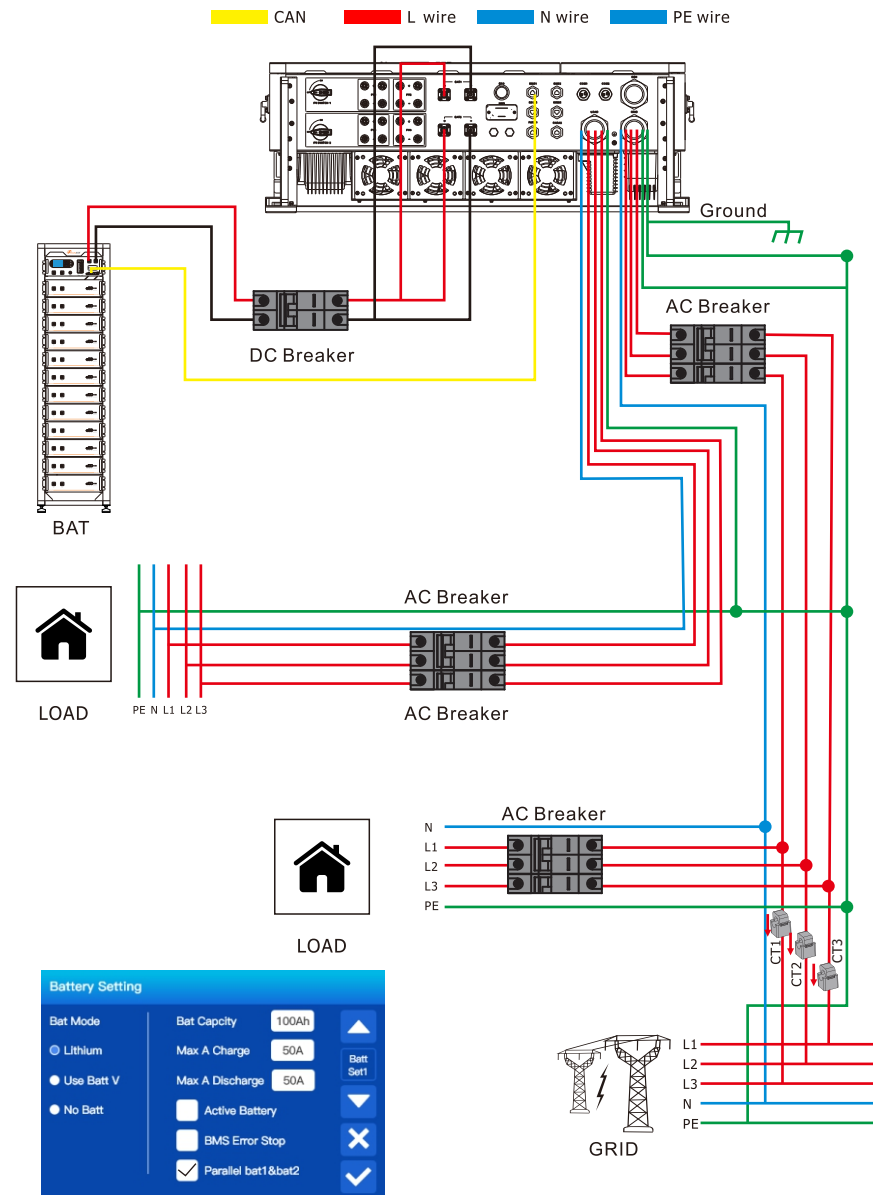

4.10 Typical application diagram of diesel generator

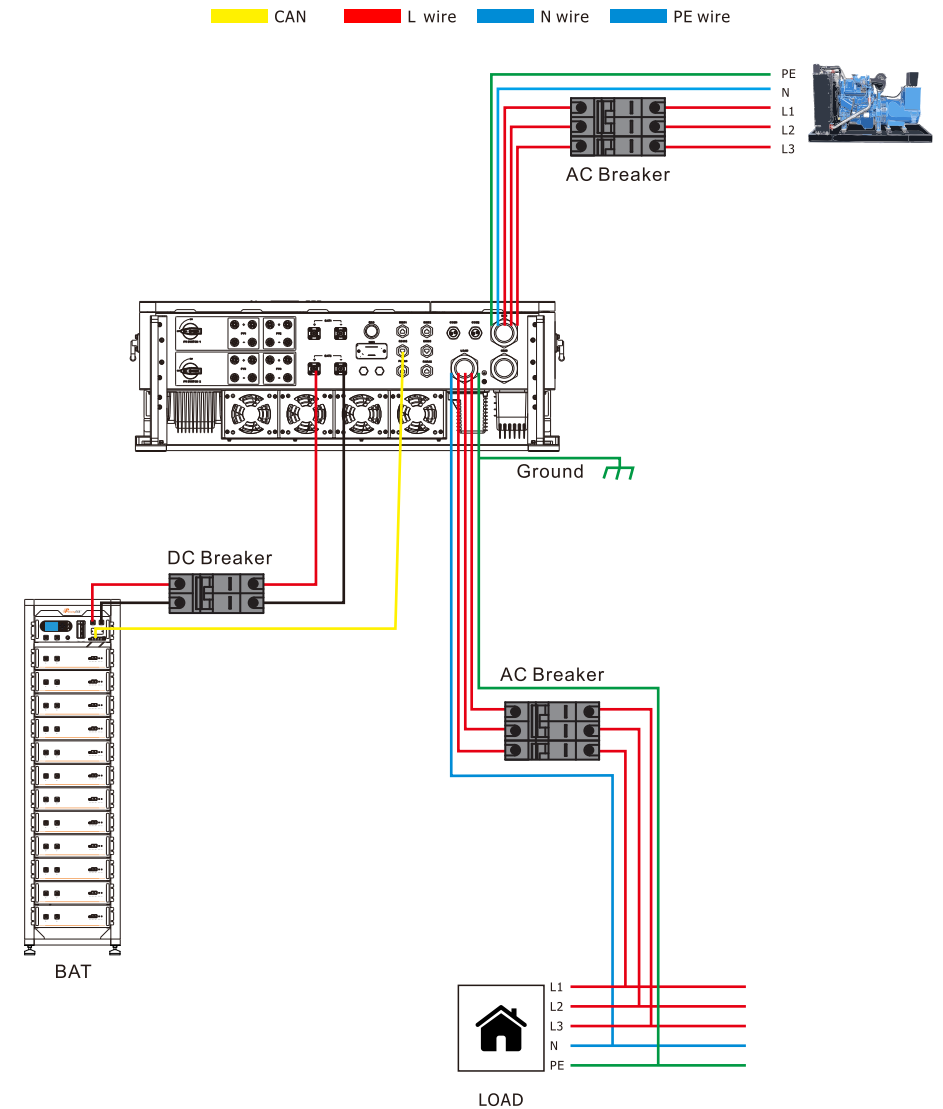

5. Display and operation

This chapter describes the panel displaying and how to operate on the panel, which involves the LCD display, LED indicators and operation panel.

5.1 Operation and Display Panel

Once the unit has been properly installed and the batteries are connected well, simply press ON/OFF button (located on the down side of the case) to turn on the unit. When system without battery connected, but connect with either PV or grid, and ON/OFF button is switched off, LCD will still light up (Display will show OFF), In this condition, when switch on ON/OFF button and select NO battery, system can still working.

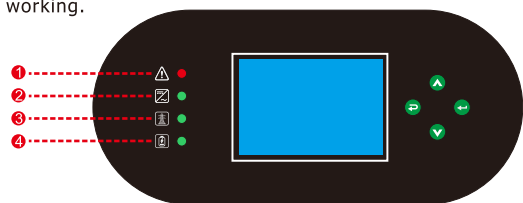

Numeber	LED Indicator	Messages	
1	Alarm/Fault	Red led solid light	Fault or warning
2	DC/AC	Green led solid light	Inverter connection normal
3	GRID	Green led solid light	Grid connection normal
4	BATTERY	Green led solid light	Battery operating normal

Chart 4-1 LED indicators

Function Key	Description
Esc	To exit setting mode
Up	To go to previous selection
Down	To go to next selection
Enter	To confirm the selection

Chart 4-2 Function Buttons

5.2 LCD Display Icons

The LCD is touchscreen, below screen shows the overall information of the inverter.



- The icon in the center of the home screen indicates that the system is Normal operation. If it turns into "comm./F01~F100", it means the inverter has communication errors or other errors, the error message will display under this icon (F01-F100 errors, detail error info can be viewed in the System Alarms menu).
- At the top of the screen is the time.
- System Setup Icon, Press this set button, you can enter into the system setup screen which including Basic Setup, Battery Setup, Grid Setup, System Work Mode, Generator port use, Advanced function .
- The main screen showing the info including Solar, Grid, Load and Battery. Its also displaying the energy flow direction by arrow. When the power is approximate to high level, the color on the panels will changing from green to red so system info showing vividly on the main screen.

- PV power and Load power always keep positive.
- Grid power negative means sell to grid, positive means get from grid.
- Battery power positive means charge, negative means discharge.

5.3 Solar Power Curve

	<p>This is Solar Panel detail page. Press the "Energy" button will enter into the power curve page.</p> <ol style="list-style-type: none"> Solar Panel Generation. Voltage, Current, Power for each MPPT. Daily and total PV production.
	<p>This is Inverter detail page.</p> <ol style="list-style-type: none"> Inverter Generation. Voltage, Current, Power for each Phase. AC-T: mean Heat-sink temperature.
	<p>This is Back-up Load detail page. Press the "Energy" button will enter into the power curve page.</p> <ol style="list-style-type: none"> Back-up Power. Voltage, Power for each Phase. Daily and total backup consump on

Grid

L1:0V	P1:0KW	CT1:0KW
L2:0V	P2:0KW	CT2:0KW
L3:0V	P3:0KW	CT3:0KW
F:0Hz	P:0KW	

SELL

Today=0.0 kWh

Total =8.60 kWh

BUY

Today=2.2 kWh

Total =11.60 kWh

This is Grid detail page.
Press the "Energy" button will enter into the power curve page.

1. Status, Power, Frequency.
2. L: Voltage for each Phase
- CT: Power detected by the external current sensors
- LD: Power detected using internal sensors on AC grid in/out breaker
3. BUY: Energy from Grid to Inverter, SELL: Energy from Inverter to grid

5.4 Battery Setting

Bat Mode: if we have a BMS communication to the battery bank connected to inverter, we will click Lithium, and if we do not have a BMS communication to the battery bank connected to inverter, we will click Use Batt V, and if we do not have battery bank connected to inverter, we will click No Batt. If clicked Lithium, the inverter running and setting about battery is all based on SOC setting, if clicked Use Batt V or No Batt, the inverter running and setting about battery is all based on Voltage setting.

BMS Error Stop: if clicked the BMS Error Stop, and Bat Mode is Lithium, and the BMS communication to the battery bank is error, the inverter will shutdown. Else if not clicked the BMS Error Stop, and Bat Mode is Lithium, and the BMS communication to the battery bank is error, the inverter running and setting about battery will automatically turn from based on SOC setting to based on Voltage setting.

Capacity: it shows your battery bank 1 size to FelicityESS hybrid inverter.

Max A Charge/ Discharge: Max battery charge/discharge current.

Parallel bat1&bat2: if the inverter battery wiring ports are connected to one battery bank, please enable this function.

Auto Start Charge: Percent SOC below Auto Start Charge, system will AutoStart to charge the battery bank from the generator (or the power grid).

Exit Charge: Percent SOC reach Exit Charge, system will stop charging the battery bank from the generator (or the power grid).

Charge Current: Charge rate of Charge Current from the attached generator (or the power grid) in Amps.

Gen Charge Enable: uses the gen input of the system to charge battery bank from an attached generator, it is the main switch apply to all system work mode.

Gen State Signal: Normally open relay that closes when the Gen Charge Enable is active.

Gen Max Run Time: It indicates the longest time Generator can run in one day, when time is up, the Generator will be turned off. 24H means that it will not shut down all the time.

Note: The setting method about Grid is the same to the Gen in this page.

Note: if the setting is conflict, The Grid priority is higher than Gen in all system work mode.

Lithium protocol: This is BMS protocol. Please reference the document (Approved Battery).

Bat Shutdown: It indicates the inverter will shutdown if the SOC below this value.

Bat Low Batt: It indicates the inverter will alarm if the SOC below this value.

Bat Restart: It indicates the inverter will restart if the SOC above this value.

Bat Constant V: It indicates the Battery will charge to this value when Bat Mode is Use Batt V.

Bat Float V: It indicates the Battery will charge to this value after battery voltage reaches Bat Constant V and charge current is below than 5A last for 10min in Bat Mode is Use Batt V.

NOTE:

The typical lithium battery cell parameters are:

Item	Specification	Comment
Voltage range	2.5~3.65V	T>0°C
	2.0~3.65V	T≤0°C
Standard charge voltage	3.65V	

The typical parameters of lead-acid batteries are:

Item	Specification	Comment
Equal charging voltage	2.23~2.30V	T=25°C
Float charging voltage	2.35~2.40V	T=25°C
Max charge current	0.3C	
Discharge termination voltage	1.80V	<0.1C
	1.75V	0.1~0.2C
	1.70V	0.2~0.5C
	1.65V	0.5~0.7C
	1.50V	0.7~3.0C

5.5 System Work Mode



System Work Mode:

Selling First: This Mode allows hybrid inverter to sell back any excess power produced by the solar panels to the grid. If Time Of Use is active, the battery energy also can be sold into grid.

The PV energy will be used to power the load and charge the battery and then excess energy will flow to grid.

Power source priority for the load is as follows:

1. Solar Panels.
2. Grid.
3. Batteries (until programable SOC discharge is reached).

Zero Export To Load: Hybrid inverter will only provide power to the backup load connected. The hybrid inverter will neither provide power to the home load nor sell power to grid. The built-in CT will detect power flowing back to the grid and will reduce the power of the inverter only to supply the backup load and charge the battery.

Zero Export To CT: Hybrid inverter will not only provide power to the backup load connected but also give power to the home load connected. If PV power and battery power is insufficient, it will take grid energy as supplement. The hybrid inverter will not sell power to grid. In this mode, a CT is needed. The installation method of the CT please refer to Table 4.4-2 CT Connection. The external CT will detect power flowing back to the grid and will reduce the power of the inverter only to supply the backup load, charge battery and home load.

Solar Sell: "Solar sell" is supplement for Zero Export To Load or Zero Export To CT: when this item is active, the surplus PV energy can be sold back to grid too. When it is active, PV Power source priority usage is as follows: load consumption and charge battery and feed into grid.

Dispatch Mode: Receive power scheduling instructions by the energy management system (EMS), if ticked, inverter will charge or discharge base on the Active Power setting. in Dispatch Mode, the battery power can be sold into grid.

Active Power: the charge power(Active Power less than 0) or discharge power(Active Power greater than 0) in the Dispatch Mode.

Max. Sell power: Allowed the maximum output power to flow to grid.

Zero-export Power: for Zero Export To Load or Zero Export To CT, and the "Solar sell" is not active. it tells the grid output power threshold to ensure the hybrid inverter won't feed power to grid.

Energy Pattern: PV Power source priority.

Batt First: PV power is firstly used to charge the battery and then used to power the load. If PV power is insufficient, grid will make supplement for battery and load simultaneously.

Load First: PV power is firstly used to power the load and then used to charge the battery. If PV power is insufficient, Grid will provide power to load, but neither the battery power to load nor the Grid charge to battery.

Note: Batt First and Load First are suitable to Selling First(Time Of Use is not active) and Zero Export To Load and Zero Export To CT.

Grid Peak-shaving: when it is active, grid output power will be limited within the set value. If the load power exceeds the allowed value, it will take PV energy and battery as supplement. If still can't meet the load requirement, grid power will increase to meet the load needs.

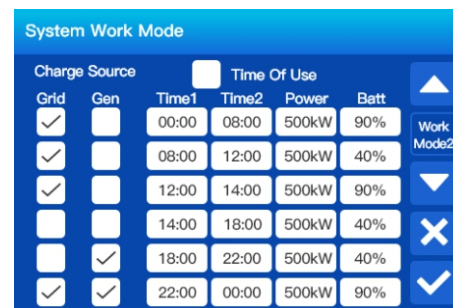

Time Of Use: it is used to program when to use grid or generator to charge the battery, and when to discharge the battery to power the load. Only tick Selling First and "Time Of Use" then the follow items (Grid, charge, time, power etc.) will take effect.

Note: when tick Selling First and click Time Of Use, the battery power can be sold into grid.

Charge Source: select grid or diesel generator to charge the battery.

Grid: use grid to charge the battery in a time period.

Gen: use diesel generator to charge the battery in a time period.

Note: if tick Grid and Gen at the same time, Grid is priority. and only the Gen Charge Enable or Grid Charge Enable is tick in chapter xx, can the corresponding Gen or Grid tick take effect.

Time: real time, range of 00:00-24:00.

Note: when the grid is present, only the Selling First and "Time Of Use" is ticked, or Dispatch Mode is ticked, can the battery will discharge. Otherwise, the battery won't discharge even the battery SOC is full. But in the off-grid mode (when grid is not available, inverter will work in the off-grid mode automatically), the battery will discharge regardless of the "Time Of Use" is ticked or not.
 Power: Max. discharge power of (battery + PV) allowed.
 Batt(V or SOC %): battery SOC % or voltage at when the action is to happen.

For example:
 During 00:00-08:00,
 if battery SOC is lower than 90%, it will use grid to charge the battery until battery SOC reaches 90%.
 During 08:00-12:00,
 if battery SOC is higher than 40%, hybrid inverter will discharge the battery until the SOC reaches 40%. At the same time, if battery SOC is lower than 40%, then grid will charge the battery SOC to 40%.
 During 12:00-14:00,
 if battery SOC is lower than 90%, it will use grid to charge the battery until battery SOC reaches 90%.
 During 14:00-18:00,
 when battery SOC is higher than 40%, hybrid inverter will discharge the battery until the SOC reaches 40%.if battery SOC is lower than 40%, neither the diesel generator nor the grid will charge the battery.
 During 18:00-20:00,
 when battery SOC is higher than 40%, hybrid inverter will discharge the battery until the SOC reaches 40%. At the same time, if battery SOC is lower than 40%, then diesel generator will charge the battery SOC to 40%.
 During 22:00-00:00,
 if battery SOC is lower than 90%, it will use grid or diesel generator to charge the battery until battery SOC reaches 90%.

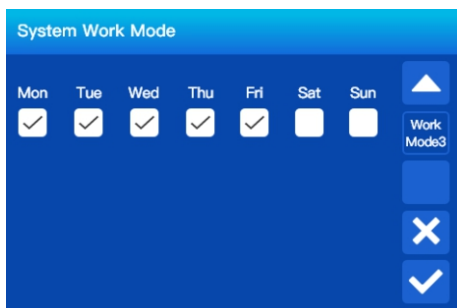

It allows users to choose which day to execute the setting of "Time Of Use".
 For example, the inverter will execute the time of use page on Mon/Tue/Wed/Thu/Fri only.

5.6 Grid Setting

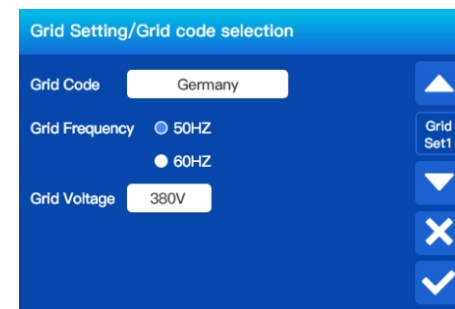

Grid Code: 0:Germany,1:Warehouse,2:50Hz grid default,3: 60Hz grid default,4:Italy,5:Britain,6:Australia,7:New Zealand,8:South African,9:cNetherland,10:cBrazil,11: EN50549,12: Poland,13. Czech.

Grid Frequency: Select the corresponding frequency level to match to the Local grid frequency.
 Grid Voltage: Select the corresponding voltage level to match to the Local grid voltage.

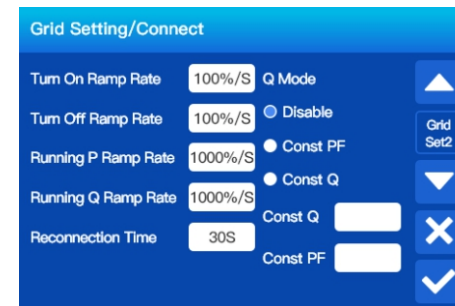

Turn On Ramp Rate: It is the startup and reconnection power ramp, for example, Turn On Ramp Rate = 100%/s, means the output power will increase from 0kw to 100% rated power in 1s.

Running P Ramp Rate: It is the power ramp response to the active power reference in normal running.

Reconnection Time: The waiting time period for the inverter connects the grid again.

Q Mode: Inverter response to the reactive power mode. Disable: not responding to the reactive power mode. Const PF: Inverter output a setting power factor(cos φ)value. Const Q: Inverter output a setting reactive power value.

Const PF: setting the power factor(cos φ)value. Const PF>0 means Inverter output Inductive reactive power(or inverter will absorb capacitive reactive power from the power grid),Const PF<0 means Inverter output capacitive reactive power.

Const Q: setting the reactive power value. Const Q >0 means Inverter output capacitive reactive power, Const Q <0 means Inverter output Inductive reactive power.

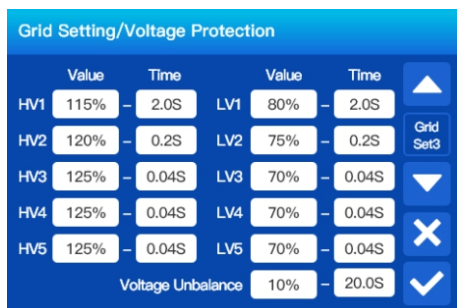

HV1: Level 1 overvoltage protection point and protection time;
 HV2: Level 2 overvoltage protection point and protection time;
 HV3: Level 3 overvoltage protection point and protection time;
 HV4: Level 4 overvoltage protection point and protection time;
 HV5: Level 5 overvoltage protection point and protection time;
 LV1: Level 1 undervoltage protection point and protection time;
 LV2: Level 2 undervoltage protection point and protection time;
 LV3: Level 3 undervoltage protection point and protection time;
 LV4: Level 4 undervoltage protection point and protection time;
 LV5: Level 5 undervoltage protection point and protection time;
 Voltage Unbalance: Grid voltage unbalance percentage protection point and protection time.

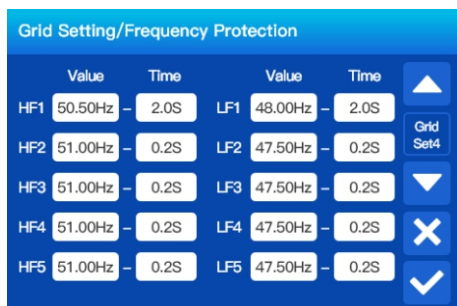

Hf1: Level 1 over frequency protection point and protection time;
 HF2: Level 2 over frequency protection point and protection time;
 HF3: Level 3 over frequency protection point and protection time;
 HF4: Level 4 over frequency protection point and protection time;
 HF5: Level 5 over frequency protection point and protection time;
 LF1: Level 1 under frequency protection point and protection time;
 LF2: Level 2 under frequency protection point and protection time;
 LF3: Level 3 under frequency protection point and protection time;
 LF4: Level 4 under frequency protection point and protection time;
 LF5: Level 5 under frequency protection point and protection time.

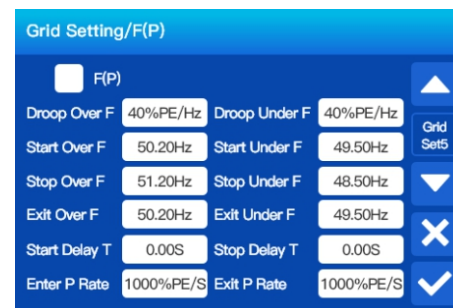

F(P): Active power response to frequency deviation
 Droop Over F: decreases the power percentage of nominal power per Hz. For example, "Start Over F=50.2Hz, Stop Over F=51.2 Hz, Droop Over F =40%PE/Hz", define the current Grid Frequency is Fg, when the grid frequency reaches 50.2Hz, the inverter will decrease its active power at Droop of 40%. The total decrease active power=(Fg- Start Over F) * Droop Over F * Pn. when grid frequency is larger than 51.2Hz, the active power will stop decreasing.
 Start Delay T: when the grid frequency reaches Start Over F, the inverter will activating active power response to over frequency after a dead time Start Delay T.
 Exit Over F :The output power is kept constant until the frequency falls below Exit Over F for a configurable time Stop Delay T.
 For the detailed setup values, please follow the local grid code.

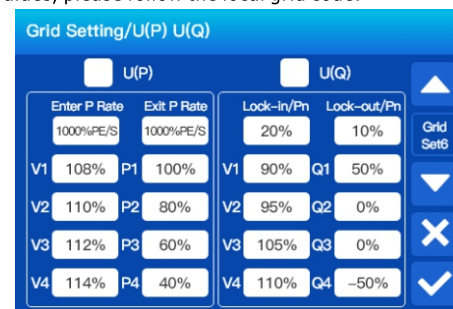

U(P): Active power response to Voltage deviation
 For example: V1=108%, V2=110%, P1=100%,P2=80%. When the grid voltage reaches the 110% times of rated grid voltage, the inverter will limited its output active power to 80% rated power.
 U(Q): controls the reactive power output as a function of the voltage
 For example: V1=90%, Q1=50%, V2=95%, Q2=0%, V3=105%, Q3=0%, V4=110%, Q4=-50%.
 When the grid voltage reaches the 95% times of rated grid voltage ,inverter will start to control the Postive reactive power(capacitive reactive power) output as a function of the voltage , When the grid voltage reaches the 90% times of rated grid voltage, inverter output power will output 50% reactive output power. When the grid voltage reaches the 105% times of rated grid voltage ,inverter will start to control the Negative reactive power(Inductive reactive power) output as a function of the voltage , When the grid voltage reaches the 110% times of rated grid voltage, inverter output power will output -50% reactive output power.
 Lock-in/Pn: When the inverter active power is larger than Lock-in/Pn rated power, the U(Q) mode will take effect.
 Lock-out/Pn: If the inverter active power is less than Lock-out/Pn rated power, the VQ mode will not take effect.
 For the detailed setup values, please follow the local grid code.

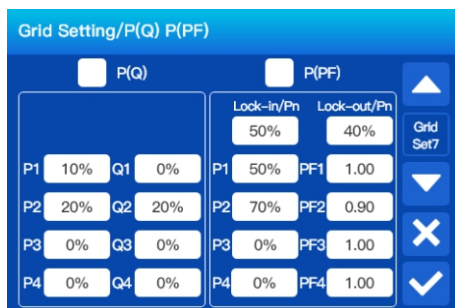

P(Q):controls the reactive power of the output as a function of the active power output.
 For example: P1=10%, Q1=0%, P2=20%,Q2=20%. When the active power output reaches the 10% times of rated power, inverter will start to control the reactive power output as a function of the active power output, When the active power output reaches the 20% times of rated power, inverter will increase 20% times of reactive power(Inductive reactive power).
 P(PF):controls the PF(cos φ) of the output as a function of the active power output.
 For example: P1=50%, PF=1.0, P2=70%,P2=0.9. When the active power output reaches the 50% times of rated power, inverter will start to control the PF as a function of the active power output, When the active power output reaches the 70% times of rated power, inverter will response to a new PF=0.9(Inductive reactive power).
 Lock-in/Pn: When the inverter output active power is higher then Lock-in/Pn rated power, it will enter the P(PF) mode.
 Lock-out/Pn: When the inverter output active power is lower then Lock-out/Pn rated power, it will exit the P(PF) mode.

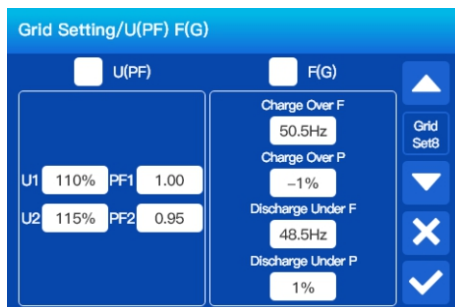

U(PF):controls the PF(cos φ) of the output to the Voltage deviation.
 For example: U1=110%, PF=1.0, U2=115%,P2=0.9. When the grid voltage reaches the 110% times of rated voltage, inverter will start to control the PF as a function of the grid voltage, When the grid voltage reaches the 115% times of rated voltage, inverter will response to a new PF=0.9(Inductive reactive power).
 F(G):controls the active power output to the grid frequency deviation.
 For example: Charge Over F=50.5, Charge Over F =-1%, Discharge Under F=48.5, Discharge Under F =1%. If the inverter is in discharge status and when the grid frequency is higher than 50.5Hz, inverter will stop discharge and controls to the charge status with charge power=-1%, If the inverter is in charge status and when the grid frequency is lower than 48.5Hz, inverter will stop charge and controls to the discharge status with discharge power=1%.

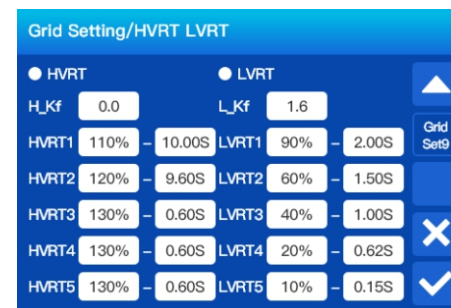

HVRT: High Voltage Ride Through enable
 H_Kf: dynamic reactive power factor in HVRT. if the local grid code requires dynamic reactive power support capability in grid high voltage, and the grid voltage is higher than HVRT1 value, the inverter will output reactive current $I_q = H_Kf * (V_{grid} - HVRT1) * I_n$.
 LVRT: Low Voltage Ride Through enable
 L_Kf: dynamic reactive power factor in LVRT. if the local grid code requires dynamic reactive power support capability in grid low voltage, and the grid voltage is lower than LVRT1 value, the inverter will output reactive current $I_q = L_Kf * (V_{grid} - LVRT1) * I_n$.
 HVRT1: Level 1 overvoltage protection point and enter HVRT Voltage point and protection time;
 HVRT2: Level 2 overvoltage protection point and protection time;
 HVRT3: Level 3 overvoltage protection point and protection time;
 HVRT4: Level 4 overvoltage protection point and protection time;
 HVRT5: Level 5 overvoltage protection point and protection time;
 LVRT1: Level 1 undervoltage protection point and enter LVRT Voltage point and protection time;
 LVRT2: Level 2 undervoltage protection point and protection time;
 LVRT3: Level 3 undervoltage protection point and protection time;
 LVRT4: Level 4 undervoltage protection point and protection time;
 LVRT5: Level 5 undervoltage protection point and protection time.

5.7 Generator Setting

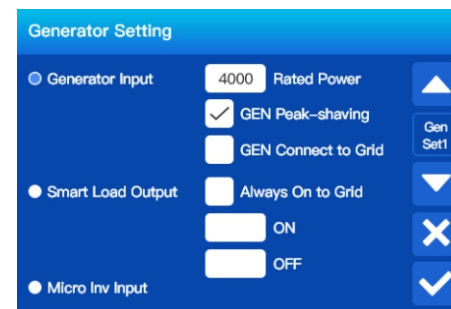

The generator port can be used as three types of ports functions: as the Generator Input, as the Smart Load Output, as the Micro Inv Input.
 Generator Input: the port is connect the diesel generator.
 Rated Power: allowed Max. power from diesel generator.
 Gen Peak-shaving: Enable When the power of the generator exceeds the Rated Power, the inverter will provide the redundant part to ensure that the generator will not overload.

GEN Connect to Grid: connect the diesel generator to the grid input port.

Smart Load Output: This ports functions means the generator port connection as an output which only receives power when the battery SOC is above a user programmable threshold.

ON: Smart Load ON Battery SOC point, Battery SOC at which the Smart load will switch on.

OFF: Smart Load OFF Battery SOC point, Battery SOC at which the Smart load will switch off.

Micro Inv Input: reserved

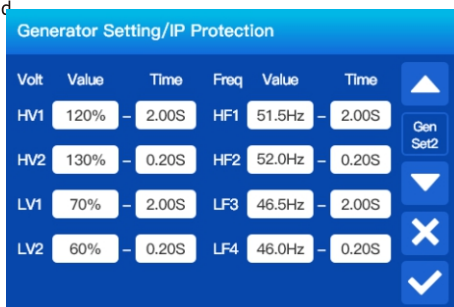

HV1: Level 1 overvoltage protection point and protection time;

HV2: Level 2 overvoltage protection point and protection time;

LV1: Level 1 undervoltage protection point and protection time;

LV2: Level 2 undervoltage protection point and protection time;

HF1: Level 1 over frequency protection point and protection time;

HF2: Level 2 over frequency protection point and protection time;

LF1: Level 1 under frequency protection point and protection time;

LF2: Level 2 under frequency protection point and protection time.

Advanced Function



DRM: For AS4777 standard.

CT Ratio: the CT ratio of the zero-export to CT mode.

GFCI: the ground-fault circuit interrupter function.

GFCI Value: Leakage current protection point.

ISO: the PV and the battery wiring terminals Positive to ground and negative to ground insulation impedance detection.

ISO Value: insulation impedance protection point.

Active Islanding: Active islanding detection enable or not.

Voltage Adjust: if the inverter is working at off grid, we can adjust the output voltage by Voltage Adjust.

Asymmetric Feeding: If it was clicked, the inverter will take power from the grid balance of on each phase (L1/L2/L3).

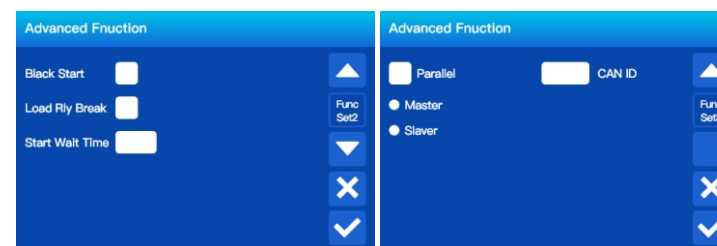

Parallel: if user want to parallel operation to Expand system capacity, we need to click the parallel. And in a parallel system, we can have and must have only one Master, and the others must be set as Slaver, and we need to set a unique CAN ID to each inverter, the CAN ID is from 1 to 10.

6. Work Mode

6.1 Selling First

6.1.1 "Selling First" and "Time Of Use" is ticked

In this mode, it is used to program when to use grid or generator to charge the battery, and when to discharge the battery to power the load. (Assuming the maximum charging power and maximum discharging power of the battery is 30kW in the following example)

(1) If inverter is currently discharging, the priority order of Discharge supply source is PV > Battery.

Example1: PV < Discharge + Load, PV and Bat provide power to the Load and Discharge together.



Example2: PV > Discharge + Load, PV provides power to the Load and Discharge, and the excess power produced by the PV will charge BAT. If PV > Bat + Discharge + Load, In order to fully utilize PV, the excess power produced by the PV will add to the Discharge.



Example3: PV + Bat < Discharge + Load, in order to keep the source power and the load power balance, it will reduce the Discharge.



(2) If inverter is currently charging, the priority order of charging Bat supply source is PV > Discharge.
 Example1: PV + Charge < Bat + Load, PV and Charge provide power to the Load and Bat together.



Example2: PV + Charge > Bat + Load, In order to fully utilize PV, it will reduce the excess power produced by the Charge.



Example3: Load > PV + Bat + Charge, in order to keep the source power and the load power balance, it will increase the Charge.



6.1.2 "Selling First" and "Time Of Use" is not ticked

This Mode allows hybrid inverter to sell back any excess power produced by the solar panels to the grid. (Assuming the maximum charging power of the battery is 30kW in the following example)

(1) "Batt First" is ticked

Example1: PV > Load + Bat, PV will charge the Bat, and then power to the Load, and the excess power produced by the PV will selling to the power grid.



Example2: Load + Bat > PV > Bat, PV will charge the Bat, the excess power produced by the PV and the power grid will power to the Load together.



Example3: PV < Bat, the PV and the power grid will charge the Bat and power to the Load together.



(2) "Load First" is ticked

Example1: PV > Load + Bat, PV will power to the Load, and then charge the Bat, and the excess power produced by the PV will selling to the power grid.



Example2: Load + Bat > PV > Load, PV will power to the Load, and the excess power produced by the PV will charge the Bat. It will not charge the Bat from the power grid.



Example3: PV < Load, the PV and the power grid will power to the Load together. It will not charge the Bat from the power grid.



6.2 Zero Export To Load

6.2.1 "Zero Export To Load" and "Solar Sell" is ticked

In this mode, the performance is the same as "Selling First" and "Time Of Use" is not ticked.

6.2.2 "Zero Export To Load" and "Solar Sell" is not ticked

Hybrid inverter will only provide power to the backup load connected. The hybrid inverter will neither provide power to the home load nor sell power to grid. The built-in CT will detect power flowing back to the grid and will reduce the power of the inverter only to supply the backup load and charge the battery. (Assuming the maximum charging power of the battery is 30kW in the following example)

(1) "Batt First" is ticked

Example1: $PV > Load + Bat$, PV will charge the Bat, and then power to the Load, and the excess power produced by the PV will be abandoned.



Example2: $Load + Bat > PV > Bat$, PV will charge the Bat, the excess power produced by the PV and the power grid will power to the Load together.



Example3: $PV < Bat$, the PV and the power grid will charge the Bat and power to the Load together.



(2) "Load First" is ticked

Example1: $PV > Load + Bat$, PV will power to the Load, and then charge the Bat, and the excess power produced by the PV will be abandoned.



Example2: $Load + Bat > PV > Load$, PV will power to the Load, and the excess power produced by the PV will charge the Bat. It will not charge the Bat from the power grid.



Example3: $PV < Load$, the PV and the power grid will power to the Load together. It will not charge the Bat from the power grid.



6.3 Zero Export To CT

6.3.1 "Zero Export To CT" and "Solar Sell" is ticked

In this mode, the performance is the same as "Selling First" and "Time Of Use" is not ticked.

6.3.2 "Zero Export To CT" and "Solar Sell" is not ticked

Hybrid inverter will not only provide power to the backup load connected but also give power to the home load connected. If PV power and battery power is insufficient, it will take grid energy as supplement. The hybrid inverter will not sell power to grid. In this mode, a CT is needed. The installation method of the CT please refer to Table 4.4-2 CT Connection. The external CT will detect power flowing back to the grid and will reduce the power of the inverter only to supply the backup load, charge battery and home load.

(Assuming the maximum charging power of the battery is 30kW and the home load is 5kW in the following example, and define Load = backup load + home load)

(1) "Batt First" is ticked

Example1: $PV > Load + Bat$, PV will charge the Bat, and then power to the Load, and the excess power produced by the PV will be abandoned.



Example2: $Load + Bat > PV > Bat$, PV will charge the Bat, the excess power produced by the PV and the power grid will power to the Load together.



Example3: $PV < Bat$, the PV and the power grid will charge the Bat and power to the Load together.



(2) "Load First" is ticked

Example1: $PV > Load + Bat$, PV will power to the Load, and then charge the Bat, and the excess power produced by the PV will be abandoned.



Example2: $Load + Bat > PV > Load$, PV will power to the Load, and the excess power produced by the PV will charge the Bat. It will not charge the Bat from the power grid.



Example3: $PV < Load$, the PV and the power grid will power to the Load together. It will not charge the Bat from the power grid.



7. APP Download the app

Method 1: Access <https://download.felicityess.com> using the mobile phone browser and download the latest installation package.

Method 2: Scan the following QR code and download the latest installation package.



Please refer the Fsoler End user manual, register the installer and create a plant and owner (skip this step if the account has been created). You can obtain the Fsoler End user manual by scanning the following QR code.



8. Warning Code

When fault event happens, the fault LED is flashing. At the same time, warning code, icon  is shown on the LCD screen.

Warning Code	Warning Information	Warning Information
01	Battery 1 overvoltage alarm	Battery 1 voltage is too high and the battery should be discharged.
02	Battery 2 overvoltage alarm	Battery 2 voltage is too high and the battery should be discharged.
03	Battery 1 undervoltage alarm	Battery 1 voltage is too low, the battery should be charged.
04	Battery 2 undervoltage alarm	Battery 2 voltage is too low, the battery should be charged.
09	Under-frequency derating alarm	The frequency is too low, the inverter reduce the power.
10	Over-frequency derating alarm	The frequency is too high, the inverter reduce the power.
12	Load Overload Alarm	The load is overloaded, and the load should be reduced.
13	DC lightning protection alarm	If the DC lightning protector is abnormal, check whether the lightning protector is abnormal.
14	AC lightning protection alarm	If the AC lightning protector is abnormal, check whether the lightning protector is abnormal.
16	Ambient overtemperature derating alarm	The ambient temperature is too high, and the inverter reduces the power.

18	Fan 1 alarm	Fan 1 stops abnormally, check fan wiring.
19	Fan 2 alarm	Fan 2 stops abnormally, check fan wiring.
20	Fan 3 alarm	Fan 3 stops abnormally, check fan wiring.
21	Fan 4 alarm	Fan 4 stops abnormally, check fan wiring.
22	Internal fan alarm	Internal fan stops working abnormally, check internal fan wiring.

9. Fault Code

This chapter describes the fault alarm and fault code for quick troubleshooting.

Table 7-1 Fault code

Warning Code	Warning Information	Warning Information
01	PV1 overvoltage fault	The voltage of the PV1 string is too high, check the voltage of the string
02	PV2 overvoltage fault	The voltage of the PV2 string is too high, check the voltage of the string
03	PV3 overvoltage fault	The voltage of the PV3 string is too high, check the voltage of the string
04	PV4 overvoltage fault	The voltage of the PV4 string is too high, check the voltage of the string
05	PV1 overcurrent fault	The current of the PV1 string is too large, check the string current
06	PV2 overcurrent fault	The current of the PV2 string is too large, check the string current
07	PV3 overcurrent fault	The current of the PV3 string is too large, check the string current
08	PV4 overcurrent fault	The current of the PV3 string is too large, check the string current
09	PV1 reverse connection fault	PV1 string positive and negative connection, check the string wiring
10	PV2 reverse connection fault	PV2 string positive and negative connection, check the string wiring
11	PV3 reverse connection fault	PV3 string positive and negative connection, check the string wiring
12	PV4 reverse connection fault	PV4 string positive and negative connection, check the string wiring
14	Battery 1 software overvoltage fault	Battery 1 voltage is too high, the battery should be discharged
15	Battery 2 software overvoltage fault	Battery 2 voltage is too high, the battery should be discharged
16	Battery 1 Overvoltage fault	Battery 1 voltage is too high, the battery should be discharged

17	Battery 2 Overvoltage fault	Battery 2 voltage is too high, the battery should be discharged
18	Battery 1 Undervoltage fault	Battery 1 voltage is too low, the battery should be charged
19	Battery 2 Undervoltage fault	Battery 2 voltage is too low, the battery should be charged
20	Battery 1 software overcurrent fault	Battery 1 current is too large, check the battery charge and discharge power
21	Battery 2 software overcurrent fault	Battery 2 current is too large, check the battery charge and discharge power
22	Battery 1 overcurrent fault	Battery 1 current is too large, check the battery charge and discharge power
23	Battery 2 overcurrent fault	Battery 2 current is too large, check the battery charge and discharge power
24	Battery 1 reverse connection fault	Battery 1 positive and negative poles is reversed, check the battery wiring
25	Battery 2 reverse connection fault	Battery 2 positive and negative poles is reversed, check the battery wiring
26	Battery 1 relay open circuit fault	Battery 1 relay not closing properly causing open circuit, shutdown and restart
27	Battery 2 relay open circuit fault	Battery 2 relay not closing properly causing open circuit, shutdown and restart
28	Battery 1 relay short circuit fault	Battery 1 relay not properly disconnected causing short circuit, shutdown and restart
29	Battery 2 relay short circuit fault	Battery 2 relay not properly disconnected causing short circuit, shutdown and restart
30	Battery 1 soft start fault	Battery 2 fails to raise the input voltage normally, shutdown and restart
31	Battery 2 soft start fault	Battery 2 fails to raise the input voltage normally, shutdown and restart
32	Battery 1 SOC Low fault	Battery 1 SOC is too low, the battery should be charged
33	Battery 2 SOC Low fault	Battery 2 SOC is too low, the battery should be charged
35	Bus software overvoltage fault	Bus voltage is too high, shutdown and restart.
36	Bus overvoltage fault	Bus voltage is too high, shutdown and restart.
37	Bus undervoltage fault	Bus voltage is too low, shutdown and restart.
38	Positive and negative bus imbalance fault	Positive bus voltage does not match negative bus voltage, shutdown and restart.
39	Bus soft start fault	Bus voltage fails to rise normally at startup, shutdown and restart.

Hybrid inverter

40	Bus short circuit fault	Bus short, shut down and restart.
41	Balanced Bridge Software Overcurrent Fault	Balanced bridge current is too high, shutdown and restart.
42	Balanced Bridge Overcurrent Fault	Balanced bridge current is too high, shutdown and restart.
44	Inverter soft start fault	Inverter voltage fails to rise normally at startup, shutdown and restart
45	Inverter voltage fault	Inverter voltage is too high, shutdown and restart.
46	Inverter software overcurrent fault	Inverter current is too high, check the given power and load size.
47	Inverter overcurrent fault	Inverter current is too high, check the given power and load size.
48	Inverter short circuit fault	Short circuit at inverter, shutdown and restart.
49	DSP Communication Fault	Inverter voltage DC component is too high, shutdown and restart.
50	Inverter current DC component fault	Inverter current DC component is too high, shutdown and restart.
51	Grid Overload Fault	The grid voltage is too high, check whether the grid voltage is within the normal range
52	Grid Undervoltage Fault	The grid voltage is too low, check whether the grid voltage is within the normal range
53	Grid Over-frequency Fault	The grid frequency is too high, check whether the grid frequency is within the normal range
54	Grid Underfrequency Fault	The grid frequency is too low, check whether the grid frequency is within the normal range
55	Grid Reverse Sequence Fault	The grid phase sequence is reversed, check the grid phase sequence wiring
56	Grid Overload Fault	The load of the grid access is too large, and the load should be reduced
57	Active Islanding Fault	The inverter enters active islanding
58	Grid Imbalance Fault	Grid three-phase voltage unbalance, check the grid three-phase voltage
59	Load overload 110% Fault	The load exceeds 110%, the load should be reduced
60	Load overload 125% Fault	The load exceeds 125%, the load should be reduced
61	Load overload 150% Fault	The load exceeds 150%, the load should be reduced
62	Load overload 200% Fault	The load exceeds 200%, the load should be reduced
63	EPO Fault	Inverter emergency shutdown

Hybrid inverter

64	IGBT over-temperature fault	Inverter device temperature is too high.
65	Ambient Overtemperature	The ambient temperature of the inverter is too high
66	Fan 1 Fault	Fan 1 is faulty, check whether the fan is normal
67	Fan 2 Fault	Fan 2 is faulty, check whether the fan is normal
68	Fan 3 Fault	Fan 3 is faulty, check whether the fan is normal
69	Fan 4 Fault	Fan 4 is faulty, check whether the fan is normal
70	Internal fan fault	Internal fan is faulty, check internal fan for is normal
71	EEPROM Fault	There was an error with the EEPROM write
72	12V auxiliary power supply fault	Failure of 12V auxiliary power supply.
75	MCU Communication Fault	There is an error in the MCU communication, try to upgrade the software
76	Leakage current fault	The leakage current of the inverter is too large, check the wiring of the inverter
77	PV Insulation Impedance fault	The insulation of the PV string is abnormal
78	BAT1 Insulation Impedance fault	Battery 1 insulation is abnormal
79	BAT2 Insulation Impedance	Battery 2 insulation is abnormal
83	Inverter relay open circuit fault	Inverter relay not closing properly causing open circuit, shutdown and restart
84	Short circuit fault of inverter relay	Inverter relay not properly disconnected causing short circuit, shutdown and restart
87	Parallel CAN communication	The inverter is connected to abnormal parallel communication,
88	Parallel host loss fault	Parallel host disconnects from the system, check whether the hosts is normal
91	PV hardware overcurrent fault	PV current is too high, check string current
92	BMS1 communication failure	BMS1 fails to communicate normally, check the BMS1 communication cable.
93	BMS2 communication failure	BMS2 fails to communicate normally, check the BMS2 communication cable.
94	PV side busbar rapid overvoltage	Bus voltage too high, shutdown and restart.

Appendix

Model	T-REX -50KHP3G01	T-REX -40KHP3G01	T-REX -30KHP3G01	T-REX -29K9HP3G01	T-REX -25KHP3G01
Battery Input Data					
Battery Type	LFP (LiFePO4)				
Battery Voltage Range	160~800Vd.c.				
Max. Charging Current	50+50(A)				
Max. Discharging Current	50+50(A)				
Number of battery input	2				
PV String Input Data					
Max. DC Input Power	65 kW	52 kW	39 kW	38.87 kW	32.5 kW
Max. DC Input Voltage	1000Vd.c.				
Min. DC Input Voltage	150Vd.c.				
Start-up Voltage	250Vd.c.				
Rated DC Input Voltage	600Vd.c.				
MPPT Range	200~850Vd.c.				
Full Load DC Voltage Range	450~850Vd.c.	360~850Vd.c.	360~850Vd.c.	360~850Vd.c.	450~850Vd.c.
PV Input Current	36+36+36+36(A)		36+36+36(A)		36+36(A)
Max. PV Isc	55+55+55+55(A)		55+55+55(A)		55+55(A)
No. of MPP Trackers	4		3		2
No. of Strings per MPP Tracker	2		2		2
AC Output Data					
Rated AC Output Power	50 kW	40 kW	30 kW	29.9 kW	25 kW
Max. AC Output Power	55 kW	44 kW	33 kW	29.9 kW	27.5 kW
AC Output Rated Current	72.5 A	58 A	43.5 A	43.4 A	36.3 A
Max. AC Current	79.7 A	63.8 A	47.8 A	43.4 A	39.9 A
Rated AC Voltage	220/380,230/400 Vac (-20%~+15%)				
AC Wiring Mode	3W+N+PE/3W+PE				
Rated AC Frequency	50 /60 Hz (45~55Hz/55~65Hz)				
THDI	<3% (At Rated Power)				
Power Factor	0.8(leading) to 0.8(lagging)				
Efficiency					
Max. Efficiency	97.60%				
Euro Efficiency	97.00%				
MPPT Efficiency	99.90%				

Protection	
PV Input Lightning Protection	Integrated
PV String Input Reverse Polarity Protection	Integrated
Battery Input Lightning Protection	Integrated
Battery Input Reverse Polarity Protection	Integrated
Insulation Resistor Detection	Integrated
Residual Current Monitoring Unit	Integrated
Output Over Current Protection	Integrated
Output Shorted Protection	Integrated
Output Over Voltage Protection	Integrated
Anti-islanding Protection	Integrated
AC Output Lightning Protection	Integrated
Certification and Standards	
Grid Regulation	NRS 097-2-1,VDE4105,EN50549-1,AS 4777.2, GB/T 34120,GB/T 34133,GB/T 34129
Safety EMC / Standard	IEC/EN 61000-6-1/2/3/4,IEC/EN 62109-1,IEC/EN 62109-2
General Data	
Size (W* H* D)	940*595*340mm
Protection Degree	IP65
Operating Temperature Range	-25 to 60 °C (> 50 °C derating)
Humidity	0 ~ 95 % (No condensation)
Cooling	Smart cooling
Altitude	3000 m (> 2000 m derating)
Communication with BMS	RS485,CAN
Monitor module	WiFi/GPRS
Installation Style	Wall-mounted
Warranty[1]	10 years
[1]Conditions apply, refer to FelicityESS Warranty policy.	